

321, 321B, 321P, 321PB MULTISENSOR

The Multisensor is a compact unit that combines a light sensor for constant light control and a passive infrared (PIR) presence detector to provide energy-saving functions in a DALI system.

The light sensor measures reflected light from the surface directly beneath it. The unit uses this information to maintain a constant light level by adjusting the lamp outputs.

The PIR sensor enables the Multisensor to switch the lights on when its coverage area is occupied, and off when it is unoccupied.

The sensor's settings are adjusted using Helvar's Designer or Toolbox software.

Due to its excellent detection performance, the Multisensor is especially suitable for applications where small or slow movements take place for extended periods of time, such as offices or classrooms. Since its detection sensitivity is less dependent on movement direction than that of most PIR sensors, fewer units are required to reliably cover a target area.

The unit can be mounted into a ceiling void or onto a solid surface using Helvar's SBB-C (white) or SBB-CB (black) mounting box (sold separately).

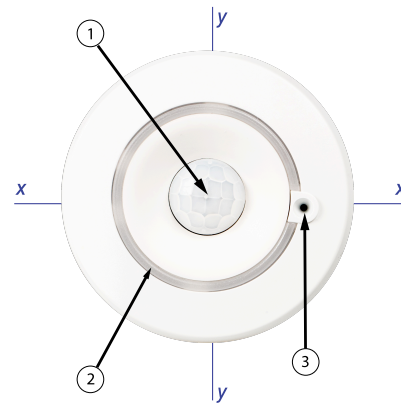

1. PIR sensor
2. Status LED
3. Light sensor

Key Features

- Excellent detection performance through high sensitivity and multidirectional coverage.
- Programmable constant light control for energy efficiency.
- 10 mA DALI current consumption.
- Compact and functional design.
- Programmable in Designer and Toolbox.

Constant Light Coverage

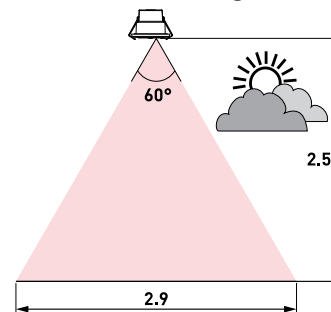

Presence Detection Coverage at 2.5 m Height

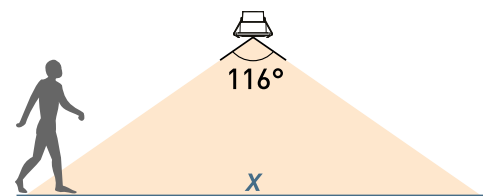
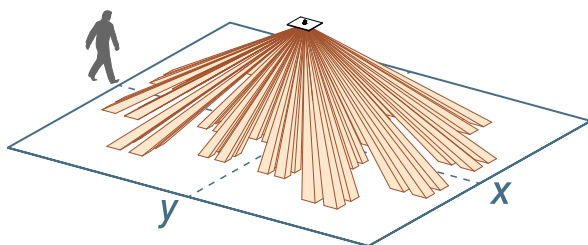

X-Axis Coverage

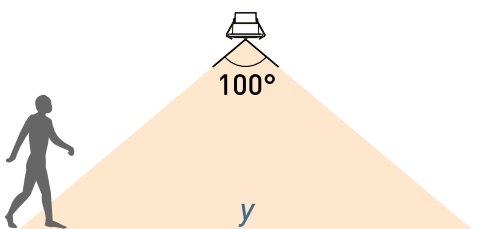

Y-Axis Coverage

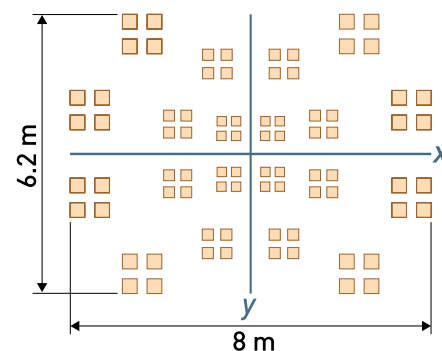

Detection Pattern at Floor Level

Dimensions (mm)

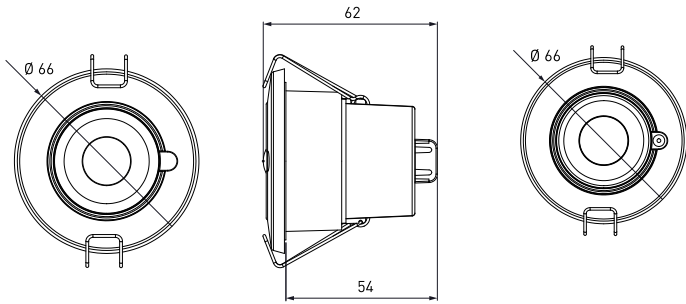

321, 321B

321P and 321PB

Connections

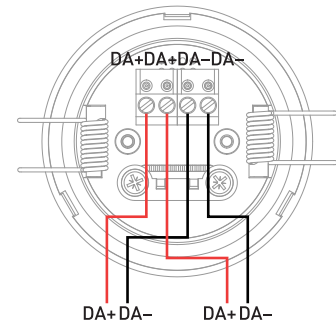

Technical Data

Connections	
DALI:	Removable connector block
Wire section:	0.5 mm ² – 1.5 mm ² solid or stranded
Cable rating	All cables must be mains rated.

Electrical data	
DALI supply input:	12 V – 22.5 V
DALI consumption:	10 mA Max

Sensors	
Light sensor:	For constant-light functions
Presence detector:	Passive infrared (PIR)

Operating and storage conditions	
Ambient temperature:	0 °C to +50 °C
Relative humidity:	Max. 90 %, noncondensing
Storage temperature:	-10 °C to +70 °C

Conformity and standards	
Conformity:	
EMC emission:	EN 55015
EMC immunity:	EN 61547
Safety:	EN 61347-2-11
Environment:	Complies with WEEE and RoHS directives.

Mechanical data	
Max. recommended mounting height:	4 m
Presence detection coverage area:	46 m ² @ 2.5 m mounting height
Mounting hole diameter:	51 mm +/- 1 mm
Note: If replacing older sensor then 52 mm to 55 mm mounting hole is acceptable.	
Ceiling thickness:	Maximum 25mm
Bezel diameter:	66 mm
Recommended clearance depth:	10 cm (with cable cover, incl. 5 cm for cabling)
Material (casing):	Nonflammable PC/ABS (UL94-V0)
Finish/Colour:	321, 321P: Semi-matt / White RAL 9003 321B, 321PB: Semi-matt / Anthracite grey RAL 7016
Weight:	66.3 g
IP rating:	321, 321B: IP30 [IP20 cable cover] 321P, 321PB: IP65

Software compatibility	
Designer:	5.4 or later
Toolbox:	2.4.2 or later